

# ztiryakiler

SAVUNMA EKİPMANLARI SAN. TİC. A.Ş.



2021

SAHRA YAŞAM ÜNİTELERİ  
MOBILE FIELD LIVING UNITS

- 05**  
**08** SEYYAR SAHRA MUTFAK ÜNİTESİ  
*FIELD KITCHEN UNIT*
- 09**  
**12** SEYYAR SAHRA FIRIN ÜNİTESİ  
*FIELD BAKERY UNIT*
- 13**  
**16** SEYYAR SAHRA BANYO ÜNİTESİ  
*FIELD SHOWER UNIT*
- 17**  
**20** SEYYAR HELA VE EL-YÜZ YIKAMA ÜNİTESİ  
*TOILET AND SANITARY UNIT*
- 21**  
**24** SEYYAR SAHRA ÇAMAŞIR YIKAMA ÜNİTESİ  
*FIELD LAUNDRY UNIT*
- 25**  
**28** SEYYAR SAHRA BULAŞIK YIKAMA ÜNİTESİ  
*FIELD DISH WASHING UNIT*
- 29**  
**32** SEYYAR SU ARITMA VE DEPOLAMA ÜNİTESİ  
*MOBILE WATER PURIFICATION AND STORAGE UNIT*
- 33**  
**34** SEYYAR SAHRA SOĞUK HAVA ÜNİTESİ  
*FIELD COLD ROOM UNIT*
- 35**  
**36** SEYYAR ÇAMAŞIR DEPOLAMA ÜNİTESİ  
*LAUNDRY STORAGE UNIT*
- 37**  
**38** SEYYAR SAHRA UN DEPOLAMA ÜNİTESİ  
*FIELD FLOUR STORAGE UNIT*
- 39**  
**40** SEYYAR SAHRA ERZAK DEPOLAMA ÜNİTESİ  
*MOBILE FIELD FOOD STORAGE UNIT*





TR

20 feet ISO çelik konteynerler kara, hava, deniz vasıtalarıyla ve ulusal/uluslararası taşıma araçlarıyla taşınabilir altyapıya sahiptir ve CSC sertifikalıdır. Konteynerde 4 adet kaldırma ve dengeleme ayağı mevcuttur. Dengeleme ayakları arazi arızalarına göre en fazla 300 mm.'ye kadar ayarlanabilir (yükselebilir/alçaltılabilir) özelliktedir ve zemine batmaması maksadıyla 300x300 mm. ebadında taban levhaları mevcuttur. DROPS araçları ile taşınabilir niteliktedir. Konteyner dört köşe noktasından mapeklar yardımıyla halat/ kilit tertibatı geçirilerek de taşımaya elverişlidir. Konteyner, en az -35°C ile +60°C sıcaklık aralığındaki ortamlarda kullanılabilir.

➤Konteyner dış duvarında, tavana ve taban şasesinde uygun izolasyon malzemesi kullanılmaktadır.

- Taban dış yüzeyi, sızdırmazlık ve dış etkenlerden koruma amacıyla, bakteri ve haşere barındırmayan, koku yapmayan malzeme ile püskürtme yöntemi ile kaplanmıştır.
- Dış kapılar, sadece dışarıdan kilitlenebilmektedir ve kilitle olsa dahi içeriden acil çıkış kapı kolu (Panik Bar) ile açılabilir.
- Dış kapılara rüzgardan örtülmesini veya çarpmasını engellemek üzere kapı sabitleyici kanca kullanılmaktadır.
- Dış kapıların önüne hareketli, ayarlanabilir, merdiven basamakları konulmaktadır.
- Priz ve anahtarlar, sıva üstü kasalara monte edilmiştir.
- Topraklama ve yıldırım koruma sistemi vardır.
- Şebeke veya jeneratörden beslenebilir.

EN

20 feet ISO steel containers are transportable land, sea or air and national / international transport vehicles and CSC certified. There are 4 lifting and leveling feet in the container. Leveling feet can be adjusted up to 300 mm (raised / lowered) according to the land surface and 300x300 mm by the base plates in order not to sink into the ground. It is transportable by DROPS. The container is also suitable for transportation by passing rope / lock device with the help of eyebolts at four corners. The container can be used in environments with a temperature range of at least -35°C to +60°C. Suitable insulation material is used on the outer wall of the container, on the ceiling and on the base chassis. The outer surface of the base is covered by spraying method, which

does not contain bacteria and insects and does not smell, for the purpose of sealing and protection from external factors. The outer doors can only be locked from the outside, and even if locked, the emergency exit from the inside can be opened with the door handle (Panic Bar). Door stabilizer hooks are used to prevent the external doors from being closed by the wind or crashing. Movable, adjustable, stair steps are placed in front of the outer doors. Switches are mounted on surface-mounted cases. It has grounding and lightning protection system. It can be fed from the city system or generator.

FR

20 feet ISO steel containers are transportable land, sea or air and national / international transport vehicles and CSC certified. There are 4 lifting and leveling feet in the container. Leveling feet can be adjusted up to 300 mm (raised / lowered) according to the land surface and 300x300 mm by the base plates in order not to sink into the ground. It is transportable by DROPS. The container is also suitable for transportation by passing rope / lock device with the help of eyebolts at four corners. The container can be used in environments with a temperature range of at least -35°C to +60°C. Suitable insulation material is used on the outer wall of the container, on the ceiling and on the base chassis.

The outer surface of the base is covered by spraying method, which does not contain bacteria and insects and does not smell, for the purpose of sealing and protection from external factors. The outer doors can only be locked from the outside, and even if locked, the emergency exit from the inside can be opened with the door handle (Panic Bar). Door stabilizer hooks are used to prevent the external doors from being closed by the wind or crashing. Movable, adjustable, stair steps are placed in front of the outer doors. Switches are mounted on surface-mounted cases. It has grounding and lightning protection system. It can be fed from the city system or generator.



# SEYYAR SAHRA MUTFAK ÜNİTESİ FIELD KITCHEN UNIT



TR

Konteyner; elle çalıştırılabilir mekanik sistemle içerisinde ekipmanlar kurulu iken genişleyebilir (üç açılır) özelliğe sahiptir. Konteyner taşınacağı zaman genişleyebilir sistem kapatılarak ISO ölçülerine getirilerek sevk edilebilir. Mutfak 500 kişinin yemek ihtiyacını karşılayacak şekilde tasarlanmıştır. Konteyner içerisinde konvansiyonel fırın, fırın arabası, pişirme kazanı, fritöz, induksiyon ocağı, kıyırma makinesi, mikser, sebze doğrama makinesi, patates soyma makinesi, bıçak sterilizasyon cihazı, çalışma tezgahı, davlumbaz, eveye, çöp arabası, doğrama tablası ve el aletleri (bıçak, kevgir, kepçe vb.) mevcuttur. Dizel yakıtla çalışır.

- ▷ Taban döşemesi üzeri, sızdırmaz olacak şekilde en az 2/3 (iki taksim üç) mm kalınlığında çetali alüminyum yer kaplaması ile kaplanmıştır.
- ▷ Taban döşeme altına membranla su yalıtımı sağlanmıştır.

EN

*It has an expandable (three opens) feature with the manual operated mechanical system while the equipment is installed. When the container is to be transported, the expandable system can be closed to ISO measurements and shipped. The kitchen is designed to meet the food needs of 500 soldiers. There are conventional oven, oven trolley, cooking vessel, fryer, induction stove, meat grinder, mixer, vegetable chopping machine, potato peeler, knife sterilization device, workbench, hood, sink, garbage bin, chopping tray and hand tools (knife, skimmers, scoops, etc.) in the container.*

- ▷ The floor is covered with a aluminum floor covering with a thickness of 2/3 (two parts three) mm.
- ▷ Under the floor covering, membrane waterproofing is provided.

FR

*Human resource management Container; It has an expandable (three opens) feature with the manual operated mechanical system while the equipment is installed. When the container is to be transported, the expandable system can be closed and shipped to ISO measurements. The kitchen is designed to meet the food needs of 500 people. Conventional oven, oven trolley, cooking vessel, fryer, induction stove, meat grinder, mixer, vegetable chopping machine, potato peeler, knife sterilization device, workbench, hood, sink, garbage truck, chopping tray and hand tools (knife in the container, skimmers, scoops, etc.).*

- ▷ The floor covering is covered with a cheeked aluminum floor covering with a thickness of at least 2/3 (two parts three) mm.
- ▷ Under the floor covering, membrane waterproofing is provided.

- ▷ Konteynerlerin iç duvar yüzeyleri paslanmaz sac kaplıdır.
- ▷ Konteynerde;

- Kısa kenarlarının birinde tek kanatlı dış kapı
- 12000 (on iki bin) BTU kapasitesinde inverter klima.
- 1 adet 2000 W gücünde elektrikli ısıtıcı.
- Beraber taşınabilir 3000 lt kapasiteli 1 asıl ve 1 yedek temiz su tankı.
- Elektrik olmadığında sistemin çalışabilmesini sağlayacak kapasitede dizel jeneratör.
- Mutfak malzemelerini yıkayacak kapasitede 1 adet bulaşık makinesi.
- 600 litrelik erzakı muhafaza edebilecek yapıda soğutucu.

- ▷ The inner wall surfaces of the containers are stainless steel covered.
- ▷ There is a single wing outer door on one of the short sides of the container.
- ▷ The container has an inverter air conditioner with a capacity of 12000 (twelve thousand) BTU. There is a 2000 W electric heater in the container.
- ▷ 1 main and 1 spare clean water tank with 3000 lt capacity, portable with container
- ▷ Diesel generator with the capacity to operate the system when there is no electricity in the container.
- ▷ 1 dishwasher with the capacity to wash kitchen utensils in the kitchen container
- ▷ Cooler in a container that can hold at least 600 liters of food. It is diesel fueled.

- ▷ The inner wall surfaces of the containers are stainless steel doors.
- ▷ There is a single wing outer door on one of the short sides of the container.
- ▷ The container has an inverter air conditioner with a capacity of 12000 (twelve thousand) BTU. There is a 2000 W electric heater in the container.
- ▷ 1 noble and 1 spare clean water tank with 3000 lt capacity, portable with container
- ▷ Diesel generator with the capacity to operate the system when there is no electricity in the container.
- ▷ 1 dishwasher with the capacity to wash kitchen utensils in the kitchen container
- ▷ Cooler in a container that can hold at least 600 liters of food. It is diesel fueled.

# SEYYAR SAHRA MUTFAK ÜNİTESİ MOBILE FIELD KITCHEN UNIT

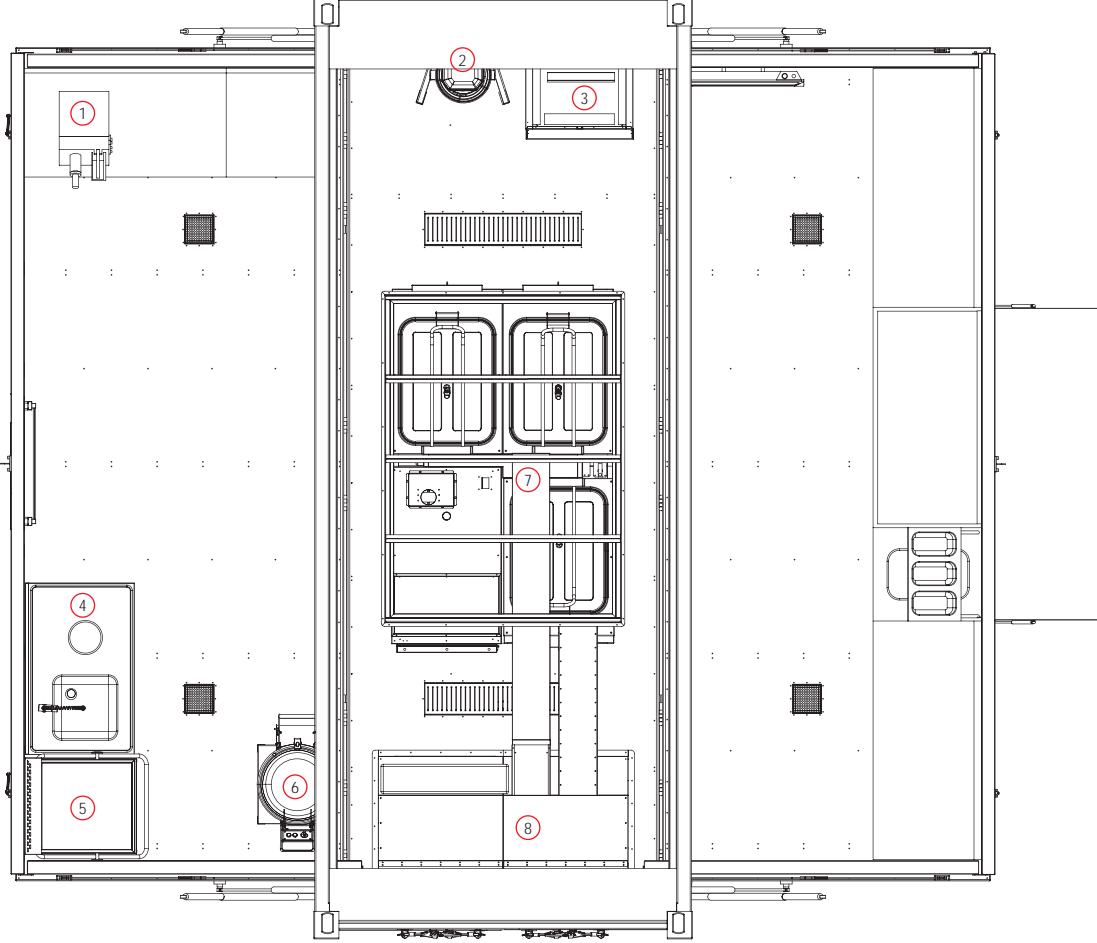

TR	EN	FR	
1	Sebze Doğrama Makinesi	Vegetable Cutting Machine	Vegetable Cutting Machine
2	Mikser	Mixer	Mixer
3	Buzdolabı	Refrigerator	Refrigerator
4	Çalışma Tezgahı	Working Bench	Working Bench
5	Bulaşık Makinesi	Dishwasher	Dishwasher
6	Patates Soyma Makinesi	Potato Peeler	Potato Peeler
7	Pişirme Ekipmanları	Cooking Island	Cooking Island
8	Klima İç Ünitesi	A/C Internal Unit	A/C Internal Unit







# SEYYAR SAHRA FIRIN ÜNİTESİ FIELD BAKERY UNIT



TR Fırın ünitesi hazırlık, pişirme ve dinlendirme konteyneri olmak üzere 3 (üç) konteynerden oluşmaktadır.

- 1- Hazırlık Ünitesi: Hamur yoğurma makinası (Mixer), kesme makinası, konik yuvarlama makinası ve ara dinlendirme bölümü
- 2- Pişirme Ünitesi: Döner Fırın, tava arabası ve mayalandırma kabini
- 3- Dinlendirme Ünitesi: Ekmek sepetleri mevcuttur.

▷ Taban döşemesi üzeri, en az 2/3 (iki taksim üç)mm kalınlığında çetali alüminyum yer kaplaması ile sızdırmaz olacak şekilde planmıştır.

▷ Taban döşeme altına membranla su yalıtımı sağlanmıştır.

▷ Konteynerlerin iç duvar yüzeyleri paslanmaz sac kaplıdır.

Fırın 8 saatte 6240 adet (150 gr'lık) ekmek pişirebilecek

▷ kapasitededir.

Fırın ünitesinde elektrik olmadığı zamanlarda sistemin çalışabilmesini

▷ sağlayacak kapasitede dizel jeneratör mevcuttur.

Konteynere entegre edilmiş veya beraber taşınabilen en az 2000 lt kapasiteli bir asıl ve bir yedek temiz su tankı mevcuttur.

EN The oven unit consists of 3 (three) containers: preparation, cooking and resting container.

1-Preparation Unit: Cutting machine, rounding machine, automatic spiral mixer, intermediate resting cabinet.

2-Cooking Unit: Rotating oven, pan trolley, fermentation cabinet.

3-Resting Unit: Bread baskets

▷ The floor covering is covered to be leak-proof with a chelated aluminum floor covering with a thickness of at least 2/3 (two parts three) mm.

▷ Under the floor covering, membrane waterproofing is provided.

▷ The inner wall surfaces of the containers are covered with stainless sheet.

▷ There is a diesel generator with the capacity to operate the system when there is no electricity.

▷ The oven has the capacity to bake 6240 pieces (150 gr) of bread in 8 hours.

▷ There is one main and one spare clean water tank with 2000 lt capacity, which can be integrated into the container and transported together.

FR The oven unit consists of 3 (three) containers: preparation, cooking and resting container.

1-Preparation Unit: Cutting machine, rounding machine, automatic spiral mixer, intermediate resting cabinet.

2-Cooking Unit: Rotating oven, pan trolley, fermentation cabinet.

3-Resting Unit: Bread baskets

▷ The floor covering is covered to be leak-proof with a chelated aluminum floor covering with a thickness of at least 2/3 (two parts three) mm.

▷ Under the floor covering, membrane waterproofing is provided.

▷ The inner wall surfaces of the containers are covered with stainless sheet.

▷ There is a diesel generator with the capacity to operate the system when there is no electricity.

▷ The oven has the capacity to bake 6240 pieces (150 gr) of bread in 8 hours.

▷ There is one main and one spare clean water tank with 2000 lt capacity, which can be integrated into the container and transported together.

# SEYYAR SAHRA FIRIN ÜNİTESİ FIELD BAKERY UNIT

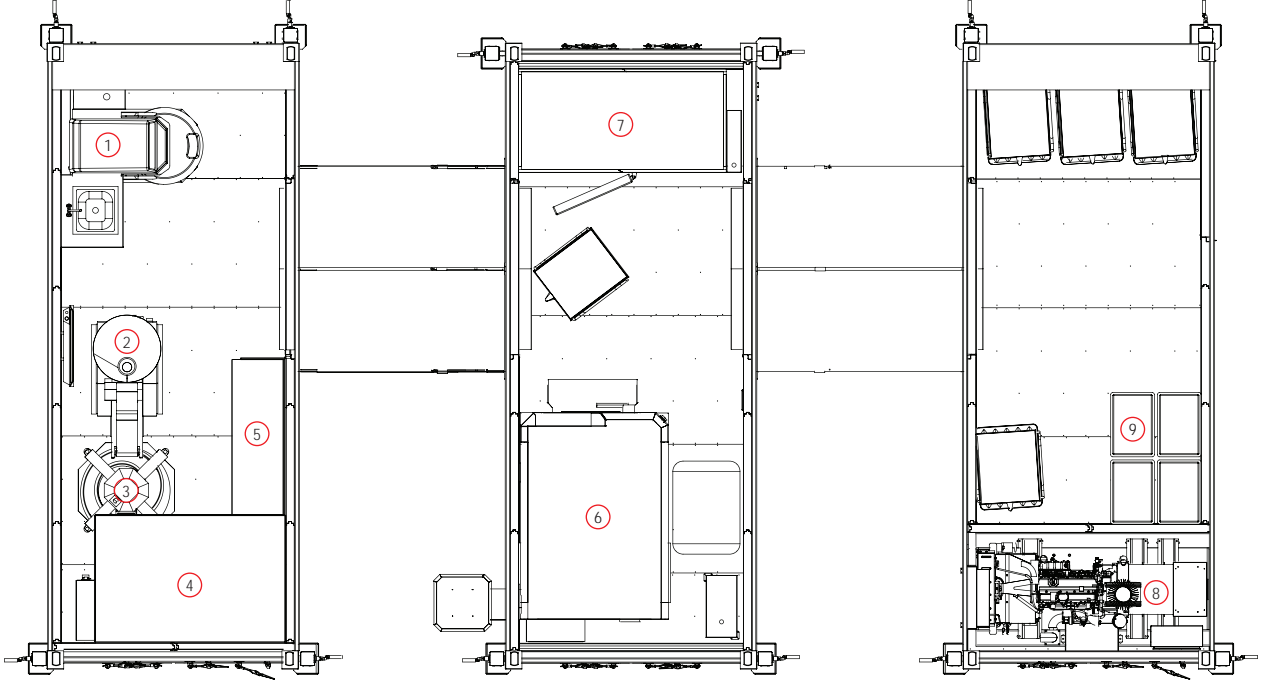

TR	EN	FR
1 Hamur Yoğurma	Spiral Mixer	Spiral Mixer
2 Kes / Tart	Dough Divider	Dough Divider
3 Hamur Yuvarlama	Dough Rounding	Dough Rounding
4 Hamur Dinlendirme	Dough Resting	Dough Resting
5 Çalışma Tezgahı	Working Bench	Working Bench
6 Döner Tepsili Fırın	Rotating Oven	Rotating Oven
7 Nemlendirme Odası ve Nem Üretici	Fermentation Cabinet	Fermentation Cabinet
8 Dizel Jeneratör	Diesel Generator	Diesel Generator
9 Ekmek Sepetleri	Bread Baskets	Bread Baskets



**YAVUMLUKA**  
KUMKAYA

**YAVUMLUKA**

**KUMKAYA** CE  
TEKNİK VERİLER  
Model No: YAVUMLUKA  
Güç: 1500 W  
Hız: 1500 rpm  
Kapasite: 10 kg  
Boyutlar: 450 x 450 x 1000 mm  
Ağırlık: 15 kg  
Garanti: 2 yıl



# SEYYAR SAHRA BANYO ÜNİTESİ FIELD SHOWER UNIT



TR

Duş bölümlerinin taban döşemesi 1.5 mm kalınlığında paslanmaz malzeme ile kaplanmıştır, dış kapı konteynerin kısa kenarındadır ve diğer kısa kenarda ise teknik oda bulunmaktadır. konteyner içerisinde 8 (sekiz) adet duş bölmesi vardır. Duş bataryası, el ayarı ile sıcak soğuk su karışımı yapabilir. Soğuk su tesisatı, şebekeden veya depodan su teminine uygundur. Duş, yer süzgeci ve lavabo pis su giderleri birleştirilerek tek çıkış olarak verilmiştir.

- Paslanmaz köşe tip süngerlik (Tekli),
- Dört adet havlu askısı, kapı iç tarafına monte edilmiş
- Duş bataryası,
- Duş panelleri
- Duş kapısı
- Askıya asılacak kıyafetleri sudan koruma amaçlı ıslak alan ile kapı arasında duş perdesi

EN

The floor of the shower sections is covered with 1.5 mm thick stainless material. The outer door is on the short edge of the container and other short side, there is a technical room. There are 8 (eight) shower cubicles. The shower faucet can mix hot cold water with hand adjustment. Equipment to prevent freezing of water in the tank in cold weather. Cold water installation to suitable for water supply from the network or water tank. Shower, floor drain and sink waste water expenses are combined and given as one outlet.

- Stainless corner type sponge holder (Single),
- Four towel racks, mounted on the inside of the door.
- Shower faucet,
- Shower panels
- Shower door
- Shower curtain between wet area and door to protect the clothes to be hung from the hanger from water

FR

The floor of the shower sections is covered with 1.5 mm thick stainless material. The outer door is on the short edge of the container and other short side, there is a technical room. There are 8 (eight) shower cubicles. The shower faucet can mix hot cold water with hand adjustment. Equipment to prevent freezing of water in the tank in cold weather. Cold water installation to suitable for water supply from the network or water tank. Shower, floor drain and sink waste water expenses are combined and given as one outlet.

- Stainless corner type sponge holder (Single),
- Four towel racks, mounted on the inside of the door.
- Shower faucet,
- Shower panels
- Shower door
- Shower curtain between wet area and door to protect the clothes to be hung from the hanger from water



- ▷ Soğuk havalarda depodaki suyun donmasını engelleyici donanım.
- ▷ Su çıkış basıncını artırıcı hidrofor sistemi.
- ▷ Suyun ısınması; dizel ısıtma sistemi.
- ▷ Sıhhi tesisatın soğuk ve sıcak su girişi ile pis su çıkışları.
- ▷ Konteynerde elektrik olmadığı zamanlarda sistemin çalışabilmesini sağlayacak kapasitede dizel jeneratör.
- ▷ Konteyner ile beraber taşınabilen 7.000 (yedi bin) Lt. kapasiteli 1 (bir) asil ve 1 (bir) yedek temiz su tankı.

- ▷ Equipment to prevent freezing of water in the tank in cold weather.
- ▷ There should be a booster system to increase the water outlet pressure.
- ▷ Heating of water; It is provided with diesel heating system.
- ▷ The sanitary installation has cold, hot water inlets and dirty water outlets.
- ▷ There is a diesel generator with the capacity to operate the system when there is no electricity in the container.
- ▷ 7,000 Lt. Capacity one main and one spare fresh water tank

- ▷ Equipment to prevent freezing of water in the tank in cold weather.
- ▷ There should be a booster system to increase the water outlet pressure.
- ▷ Heating of water; It is provided with diesel heating system.
- ▷ The sanitary installation has cold, hot water inlets and dirty water outlets.
- ▷ There is a diesel generator with the capacity to operate the system when there is no electricity in the container.
- ▷ 7,000 Lt. Capacity one main and one spare fresh water tank

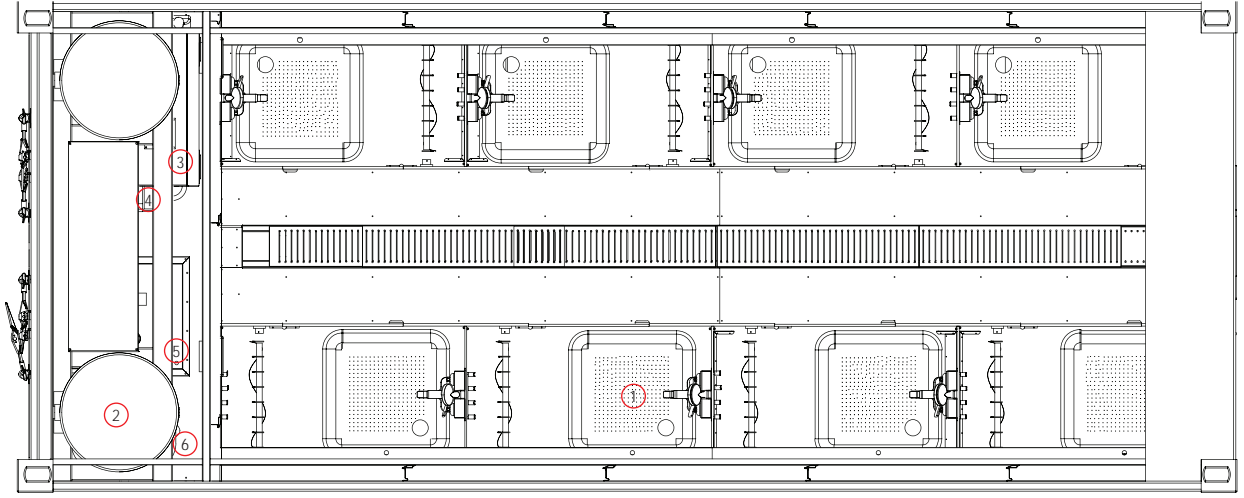
# SEYYAR SAHRA BANYO ÜNİTESİ FIELD SHOWER UNIT



	 TR	 EN	 FR
1	Duş Kabini	Shower Cubicles	Shower Cubicles
2	Boylar (2 Adet)	Boiler (2 pcs)	Boiler (2 pcs)
3	Dizel Jeneratör	Diezel Generator	Diezel Generator
4	Dizel Su Isıtıcı	Diezel Heater	Diezel Heater
5	Atık Su Pompası	Dirty Water Pump	Dirty Water Pump
6	Temiz Su Dirofor Sistemi	Clean Water Booster System	Clean Water Booster System







# SEYYAR HELA VE EL-YÜZ YIKAMA ÜNİTESİ TOILET AND SANITARY UNIT



TR

Taban döşemesi üzeri, sızdırmaz olacak şekilde 2/3 mm kalınlığında çetali alüminyum yer kaplaması ile kaplanmıştır. Taban döşeme altına membranla su yalıtımı sağlanmıştır. Tek kanatlı dış kapı, konteynerin kısa kenarlarından birinde dışa açılacak şekilde tasarlanmıştır. Soğuk su tesisatı, şebekeden veya depodan su teminine uygundur. Yer süzgeci ve lavabo pis su giderleri birleştirilerek tek çıkış olarak verilmiştir. Konteyner içerisinde 10 adet hela bölmesi bulunmaktadır, her bölme içerisinde;

- Paslanmaz çelik tuvalet taşı
- Tekli askılık
- Musluk
- Paslanmaz çelik lavabo,
- Lavabo bataryası,
- Her bir lavabo için floetal ayna
- Tuvalet kağıdı tutacağı

EN

The floor is covered with a 2/3 mm thick aluminum floor covering. Under the floor covering, membrane waterproofing is provided. On one of the short sides of the container, there is a single wing outer door to open outwards. Cold water installation is suitable for water supply from the network or water tank. Floor drain and sink waste water are combined and given as one outlet. There are 10 compartments in the container, in each compartment;

- Stainless steel toilet base
- Single hanger
- Faucets
- Stainless steel basin in suitable dimensions,
- Sink battery,
- Floetal mirror for each sink
- Toilet paper holder

FR

The floor covering is covered with a 2/3 mm thick aluminum floor covering with leakage. Under the floor covering, membrane waterproofing is provided. On one of the short sides of the container, there is a single wing outer door to open outwards. Cold water installation is suitable for water supply from the network or warehouse. Floor drain and sink waste water expenses were combined and given as one outlet. There are 10 halal compartments in the container, in each compartment;

- Stainless steel halal stone
- Single hanger
- Faucets
- Stainless steel basin in suitable dimensions,
- Sink battery,
- Floetal mirror for each sink
- Toilet paper holder

- Havluluk
- Çöp kovası
- Tuvalet fırçası
- Sıvı sabunluk

- ▷ Soğuk havalarda suyun donmasını engelleyecek donanımı.
- ▷ Su çıkış basıncını artırıcı hidrofor sistemi.
- ▷ Sıhhi tesisatın soğuk ve sıcak su girişi ile pis su çıkışları .
- ▷ Konteynerle beraber taşınabilir 3500 Lt. kapasiteli 1 asıl ve 1 yedek temiz su tankı
- ▷ Konteynerde elektrik olmadığı zamanlarda sistemin çalışabilmesini sağlayacak kapasitede dizel jeneratör

- Towel
- Trash can
- Toilet brush
- Liquid soap dispenser



- ▷ There is equipment to prevent water from freezing in cold weather.
- ▷ Booster system to increase the water outlet pressure.
- ▷ Cold and hot water inlet and waste water outlets of the sanitary system.
- ▷ 3500 Lt. portable with container 1 main and 1 spare clean water tank with a capacity
- ▷ Diesel generator with the capacity to operate the system when there is no electricity in the container

- Towel
- Trash can
- toilet brush
- Liquid soap dispenser

- ▷ There is equipment to prevent water from freezing in cold weather.
- ▷ Booster system to increase the water outlet pressure.
- ▷ Cold and hot water inlet and waste water outlets of the sanitary system.
- ▷ 3500 Lt. portable with container 1 noble and 1 spare clean water tank with a capacity
- ▷ Diesel generator with the capacity to operate the system when there is no electricity in the container

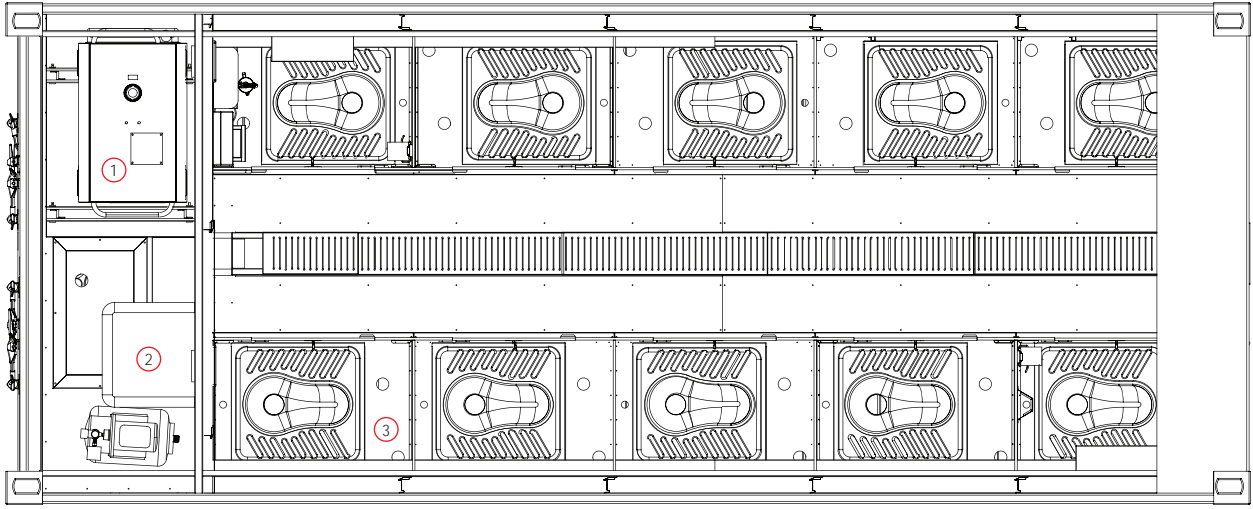
# SEYYAR HELA VE EL-YÜZ YIKAMA ÜNİTESİ MOBILE HELA AND HAND-FACE WASHING UNIT



	 TR	 EN	 FR
1	Dizel Jeneratör	Diezel Generator	Diezel Generator
2	Su Tankı	Water Tank	Water Tank
3	Tuvalet Bölmesi (10 Adet)	Cubicles (10 pcs)	Cubicles (10 pcs)





# SEYYAR SAHRA ÇAMAŞIR YIKAMA ÜNİTESİ FIELD LAUNDRY UNIT



**TR** Taban döşemesi üzeri, sızdırmaz olacak şekilde 2/3 mm. kalınlığında çetali alüminyum yer kaplaması ile kaplanmıştır. Taban döşeme altına membranla su yalıtımı sağlanmıştır. Konteyner iç duvar yüzeyleri paslanmaz sac kaplanmıştır. Konteynerin uzun kenarında çift kanatlı dış kapı

- ▷Konteynerle beraber taşınabilir 2000 lt kapasiteli bir asıl ve bir yedek temiz su tankı
- ▷Konteynerde, 1 adet 2000 W gücünde elektrikli ısıtıcı.
- ▷Konteyner içerisinde 2 adet 20 kg. kapasiteli yıkama ve 2 adet 20 kg kapasiteli kurutma makinesi

**EN** 2/3 mm floor is covered with thick aluminum floor covering. Under the floor covering, membrane waterproofing is provided. Container inner wall surfaces are covered with stainless steel. Double wing outer door on the long edge of the container.

- ▷One main and one spare clean water tank with 2000 lt capacity, portable with container
- ▷One 2000 W electric heater in the container
- ▷2 pieces washing machine and 2 dryers with 20 kg capacity

**FR** 2/3 mm floor is covered with thick aluminum floor covering. Under the floor covering, membrane waterproofing is provided. Container inner wall surfaces are covered with stainless steel. Double wing outer door on the long edge of the container.

- ▷One main and one spare clean water tank with 2000 lt capacity, portable with container
- ▷One 2000 W electric heater in the container
- ▷2 pieces washing machine and 2 dryers with 20 kg capacity



- ▷Konteyner içerisinde paslanmaz sacdan imal edilmiş 2 adet duvara asılan tipte kayar kapaklı metal dolap
- ▷Konteyner içerisinde temiz ve kirlili çamaşırları koyabilmek için 4 adet çamaşır sepeti
- ▷Konteynerde elektrik olmadığı zamanlarda sistemin çalışabilmesini sağlayacak kapasitede dizel jeneratör .

- ▷Metal Cupboard with sliding doors made of stainless steel in the container.
- ▷20 kg capacity laundry baskets to put clean and dirty laundry in the container
- ▷Diesel generator with the capacity to operate the system when there is no electricity in the container.

- ▷Metal Cupboard with sliding doors made of stainless steel in the container.
- ▷20 kg capacity laundry baskets to put clean and dirty laundry in the container
- ▷Diesel generator with the capacity to operate the system when there is no electricity in the container.

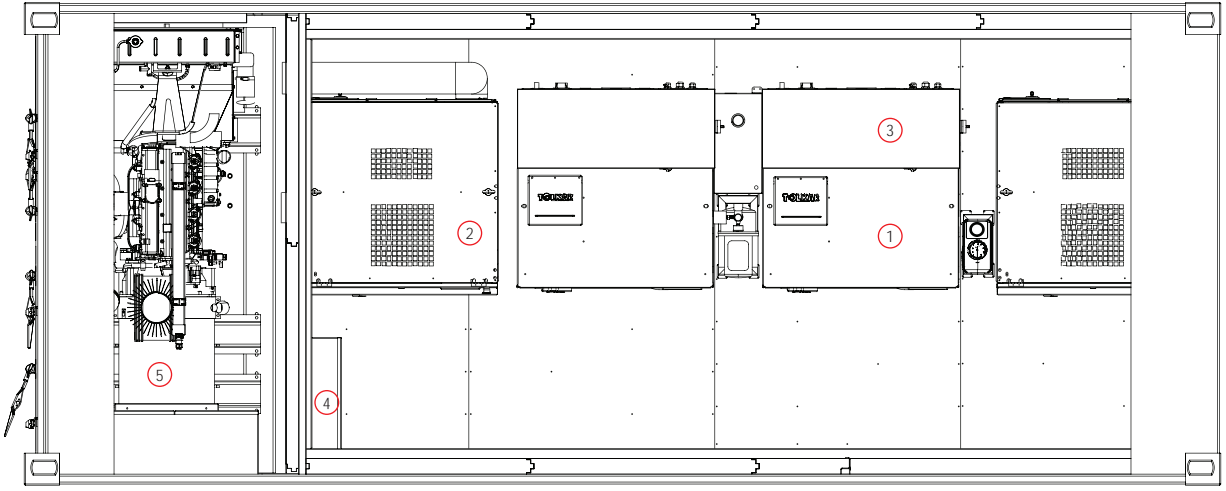
# SEYYAR SAHRA ÇAMAŞIR YIKAMA ÜNİTESİ FIELD LAUNDRY UNIT



	 TR	 EN	 FR
1	Çamaşır Yıkama Makinesi (2 Adet)	Washin Machines (2 pcs)	Washin Machines (2 pcs)
2	KKurutma Makinası (2 Adet)	Dryer (2 pcs)	Dryer (2 pcs)
3	Malzeme Dolabı (2 Adet)	Cupboard (2 pcs)	Cupboard (2 pcs)
4	Konvektör Isıtıcı	A/C	A/C
5	Dizel Jeneratör	Diezel Generator	Diezel Generator





تاسک وینا



# SEYYAR SAHRA BULAŞIK YIKAMA ÜNİTESİ FIELD DISH WASHING UNIT



TR

2 adet 1000 tabak/ saat kapasiteli, en az 3 programlı giyotin tip bulaşık makinası mevcuttur .Taban döşemesi üzeri, sızdırmaz olacak şekilde en az 2/3 mm kalınlığında çetali alüminyum yer kaplaması ile kaplanmıştır. Taban döşeme altına membranla su yalıtımı ve ıslak zemine uygun, kaymaya karşı, zemin ve duvarlar anti bakteriyel özelliklerdedir. Konteynerin kısa kenarlarının birinde yerleştirilmiş çift kanatlı dış kapı mevcuttur.

- ▷ 200 m3/Saat kapasiteli havalandırma fanı
- ▷ Konteynerle beraber taşınabilir 3500 lt kapasiteli 1 asıl ve 1 yedek temiz su tankı
- ▷ Su tankı ve su tesisatı için donmayı engelleyecek yalıtım sistemi
- ▷ Konteynerde elektrik olmadığı zamanlarda sistemin çalışabilmesini sağlayacak kapasitede dizel jeneratör

EN

2 pieces of 1000 plate / hour capacity, at least 3 program guillotine type dishwasher. The floor is covered with an aluminum floor covering with a minimum thickness of 2/3 mm that is leakproof. Membrane waterproofing under the floor covering. Floors and walls suitable for wet ground, anti-slip, anti-bacterial properties. Double wing outer door on one of the short sides of the container.

- ▷ 200 m3 / h capacity ventilation fan
- ▷ 1 main and 1 spare clean water tank with a capacity of 3500 lt.
- ▷ Diesel generator with the capacity to operate the system when there is no electricity in the container.
- ▷ 2 pieces of 1000 plate / hour capacity, at least 3 program guillotine type dishwasher.
- ▷ Stacking rack for materials.

FR

2 pieces of 1000 plate / hour capacity, at least 3 program guillotine type dishwasher. The floor is covered with an aluminum floor covering with a minimum thickness of 2/3 mm that is leakproof. Membrane waterproofing under the floor covering. Floors and walls suitable for wet ground, anti-slip, anti-bacterial properties. Double wing outer door on one of the short sides of the container.

- ▷ 200 m3 / h capacity ventilation fan
- ▷ 1 main and 1 spare clean water tank with a capacity of 3500 lt.
- ▷ Diesel generator with the capacity to operate the system when there is no electricity in the container.
- ▷ 2 pieces of 1000 plate / hour capacity, at least 3 program guillotine type dishwasher.
- ▷ Stacking rack for materials.

- ▷ 2 adet 1000 tabak/ saat kapasiteli, en az 3 programlı giyotin tip bulaşık makinası.
- ▷ Malzemelerin istiflenmesi için istif rafı.
- ▷ Tabaklardaki artıkların temizlenebilmesi için çöp arabası ve bulaşık sıyırma tezgâhi.
- ▷ Konteyner içerisinde kazan yıkamaya elverişli yıkama tezgâhi/evyesi
- ▷ 1 adet 2,5 m genişliğinde kazan yıkama evyesi.
- ▷ Tezgaha entegre edilmiş ön yıkamalar ve kazan yıkama için spreylilik hortumu.
- ▷ Bulaşık makineleri giriş tezgâhında ön yıkama için spreylilik hortumlu giriş tezgâhi.
- ▷ Gideri tek noktada birleştirilerek dışarıya atabilen sistem.

- ▷ Garbage bin and dish scraper to remove scraps from plates
- ▷ Washing table / sink suitable.
- ▷ 2,5 m wide bowl washing sink.
- ▷ Spray wash hose for prewashes and container washing integrated in the counter
- ▷ Entry bench with spray washing hose for pre-washing at the dishwasher entrance bench
- ▷ The system that can combine the waste water at a single point and throw it out

- ▷ Garbage bin and dish scraper to remove scraps from plates
- ▷ Washing table / sink suitable.
- ▷ 2,5 m wide bowl washing sink.
- ▷ Spray wash hose for prewashes and container washing integrated in the counter
- ▷ Entry bench with spray washing hose for pre-washing at the dishwasher entrance bench
- ▷ The system that can combine the waste water at a single point and throw it out

# SEYYAR SAHRA BULAŞIK YIKAMA ÜNİTESİ FIELD DISH WASHING UNIT

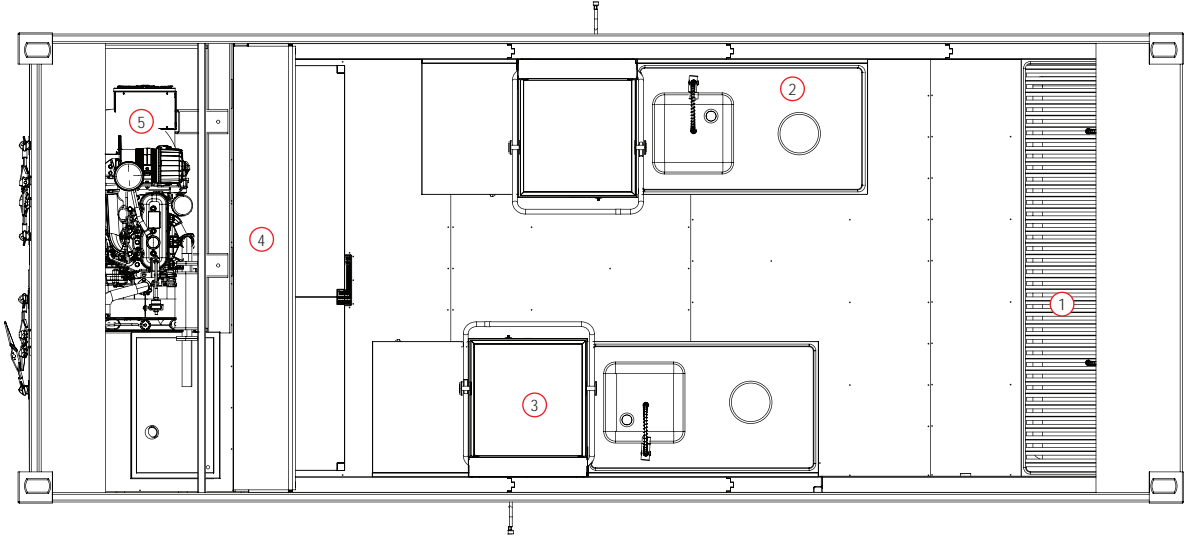

TR	EN	FR
1 Kazan Yıkama Evyesi	Washing Sink	Plastic Baskets
2 Sıyırma Tezgahı	Scraper	Drty Laundry Area
3 Bulaşık Makinesi	Dishwasher	Pres Ironing
4 İstifleme Rafı	Stacking Rack	Metal Rocks
5 Dizel Jeneratör	Diesel Generator	Clean Laundry Area





# SEYYAR SU ARITMA VE DEPOLAMA ÜNİTESİ MOBILE WATER PURIFICATION AND STORAGE UNIT



TR

Taban döşemesi üzeri, sızdırmaz olacak şekilde en az 2/3 mm kalınlığında çetallı alüminyum yer kaplaması ile kaplanmıştır. Taban döşeme altına membranla su yalıtımı yapılmıştır. Konteynerin uzun kenarlarının birinde tek kanatlı dış kapı bulunmaktadır. Sistem her türlü doğal su kaynaklarını kullanabilmektedir. Su deposu iç yüzeyleri AISI 304 kalite paslanmaz çelikten üretilmiştir.

- ▷ Sistem günlük en az 9000Lt. içme suyu artılabilmektedir.
- ▷ Konteynerde, 1 adet 2000 W gücünde elektrikli ısıtıcı.
- ▷ Su kaynaklarından su çekebilecek ve arıtılmış suyu su tanklarına basabilecek pompa ve pompa grubu.

EN

The floor covering is covered with an aluminum floor covering with a thickness of at least 2/3 mm to be leak-proof. Membrane waterproofing under the floor covering. Single wing outer door on one of the long sides of the container. The system is equipped to work in all kinds of natural water resources. Water tank inner surfaces are AISI 304 quality stainless steel.

- ▷ The system can purify 9000 Lt per day at least. drinking water can purify.
- ▷ 2000 W electric heater in the container.
- ▷ Pump and pump group that can draw water from water sources and press the treated water into water tanks.

FR

The floor covering is covered with an aluminum floor covering with a thickness of at least 2/3 mm to be leak-proof. Membrane waterproofing under the floor covering. Single wing outer door on one of the long sides of the container. The system is equipped to work in all kinds of natural water resources. Water tank inner surfaces are AISI 304 quality stainless steel.

- ▷ The system can purify 9000 Lt per day at least. drinking water can purify.
- ▷ 2000 W electric heater in the container.
- ▷ Pump and pump group that can draw water from water sources and press the treated water into water tanks.

- ▷ UV (mor ötesi) ve ters ozmos ile arıtma sistemine sahiptir.
- ▷ Konteyner içerisinde arıtılmış suyu muhafaza edecek kapasitede
- ▷ 5 adet 1000 litrelik depo
- ▷ Depo içindeki suyun donmasını önleyecek ısıtma sistemi.
- ▷ Arıtılmış suyu ilave depolayabilmek için katlanabilir özellikte 5.000 litre kapasiteli kauçuk su tankı.
- ▷ Elektrik olmadığı zamanlarda sistemin çalışabilmesini sağlayacak kapasitede dizel jeneratör.

- ▷ Purification system with UV (ultraviolet) and reverse osmosis.
- ▷ There are 5 1000 liter tanks in the container with the capacity to preserve purified water.
- ▷ Heating system to prevent freezing of water in the tank.
- ▷ Foldable 5.000 liter capacity rubber water tank for additional storage water purified.
- ▷ Diesel generator with the capacity to operate the system when there is no electricity in the container.

- ▷ Purification system with UV (ultraviolet) and reverse osmosis.
- ▷ There are 5 1000 liter tanks in the container with the capacity to preserve purified water.
- ▷ Heating system to prevent freezing of water in the tank.
- ▷ Foldable 5.000 liter capacity rubber water tank for additional storage water purified.
- ▷ Diesel generator with the capacity to operate the system when there is no electricity in the container.

# SEYYAR SU ARITMA VE DEPOLAMA ÜNİTESİ MOBILE WATER PURIFICATION AND STORAGE UNIT

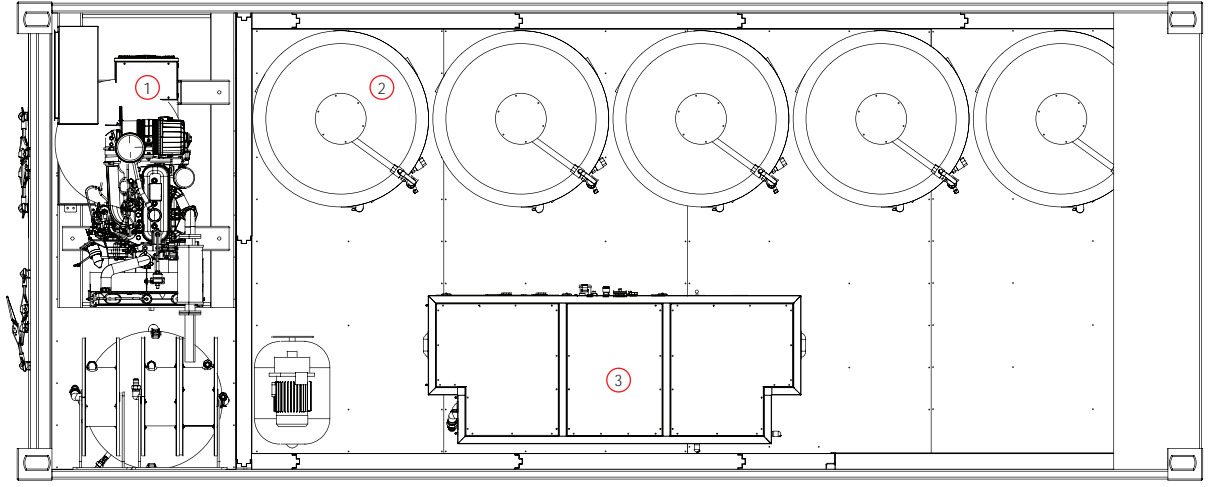

TR	EN	FR
1 DİZEL JENERATÖR	Diezel Generator	Diezel Generator
2 TEMİZ SU TANKLARI (4 ADET)	Clean Water Tank (4 pcs)	Clean Water Tank (4 pcs)
3 TERS OZMOS SU ARITMA CİHAZI	Water Purifying System	Water Purifying System

## SU ANALİZ SETİ WATER ANALYSIS SET



**TR** Suda ki amonyum, karbonat sertliği, demir, nitrat, nitrit, pH, bulanıklık, fosfat ve sertlik değerlerini tespit edebilmek için kullanılmaktadır. Kimyasal, fiziksel ve mikrobiyolojik test yapabilmektedir. İnsan sağlığını olumsuz etki eden zararlı maddeleri tesbit edip, elde edilen verileri hafızasında saklayabilmektedir. Su analiz seti uygun bir dolapta muhafaza edilebilir ve çanta içerisinde taşınabilir.

**EN** In the water to ammonium, carbonate hardness, iron, nitrate, nitrite, pH, turbidity, It is used to determine phosphate and hardness values. It can perform chemical, physical and microbiological tests. It can detect harmful substances that adversely affect human health and store the obtained data in its memory. The water analysis set can be stored in a suitable cabinet and transported in a bag.

**FR** In the water to ammonium, carbonate hardness, iron, nitrate, nitrite, pH, turbidity, It is used to determine phosphate and hardness values. It can perform chemical, physical and microbiological tests. It can detect harmful substances that adversely affect human health and store the obtained data in its memory. The water analysis set can be stored in a suitable cabinet and transported in a bag.

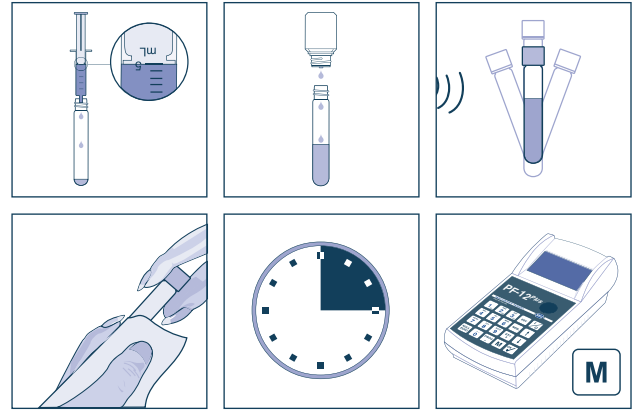





# SEYYAR SAHRA SOĞUK HAVA ÜNİTESİ FIELD COLD ROOM UNIT



**TR** Soğuk hava konteyneri 2 odalıdır, iki odaya ilave olarak girişte mekanik ekipmanların yerleştirildiği bir bölüm bulunmaktadır. Tek kanatlı dış kapı konteynerin kısa kenarlarından birine gelecek şekilde tasarlanmıştır. Soğuk hava odalarının duvarları, tavanı ve tabanı 100mm kalınlığında sökülebilir tip poliüretan tectritli paneller kaplanmıştır. Soğuk hava ünitesi, hava soğutmalı kondenserli paket tip cihaz ile çalışmaktadır. Odalardan birisi  $+0^{\circ}\text{C} / +5^{\circ}\text{C}$  arasında diğeri ise  $-18^{\circ}\text{C} / -22^{\circ}\text{C}$  derece ısı aralığına sahiptir. Her soğuk hava odası, elektronik kontrol paneli ile programlanabilmektedir. Soğutma sistemi, üzerindeki dijital termostat vasıtasıyla ayarlanan sıcaklık derecesine kadar çalışıp otomatik olarak durur.

Defrost sistemi, soğutucu üzerinde fazla buzlanma oluştuğu zaman otomatik olarak devreye girer. Soğutucunun istenilen sıcaklık ayarı dijital termostat üzerinden yapılabilir. Konteyner içerisindeki soğuk odalarda metal raflar, derin dondurucuda et askı arabası bulunmaktadır. Konteynerde elektrik olmadığı zamanlarda sistemin çalışabilmesini sağlayacak kapasitede dizel jeneratör

**EN** Soğuk hava konteyneri 2 odalıdır, iki odaya ilave olarak girişte mekanik ekipmanların yerleştirildiği bir bölüm bulunmaktadır. Tek kanatlı dış kapı konteynerin kısa kenarlarından birine gelecek şekilde tasarlanmıştır. Soğuk hava odalarının duvarları, tavanı ve tabanı 100mm kalınlığında sökülebilir tip poliüretan tectritli paneller kullanılmıştır. Soğuk hava ünitesi, hava soğutmalı kondenserli paket tip cihaz ile çalışmaktadır. Odalardan birisi  $+0^{\circ}\text{C} / +5^{\circ}\text{C}$  arasında diğeri ise  $-18^{\circ}\text{C} / -22^{\circ}\text{C}$  derece ısı aralığına sahiptir. Her soğuk hava odası, elektronik kontrol paneli ile programlanabilmektedir. Soğutma sistemi, üzerindeki dijital termostat vasıtasıyla ayarlanan sıcaklık derecesine kadar çalışıp otomatik olarak durur.



Defrost sistemi, soğutucu üzerinde fazla buzlanma oluştuğu zaman otomatik olarak devreye girer. Soğutucunun istenilen sıcaklık ayarı dijital termostat üzerinden yapılabilir. Konteyner içerisindeki soğuk odalarda metal raflar, derin dondurucuda et askı arabası bulunmaktadır. Konteynerde elektrik olmadığı zamanlarda sistemin çalışabilmesini sağlayacak kapasitede dizel jeneratör

**FR** Soğuk hava konteyneri 2 odalıdır, iki odaya ilave olarak girişte mekanik ekipmanların yerleştirildiği bir bölüm bulunmaktadır. Tek kanatlı dış kapı konteynerin kısa kenarlarından birine gelecek şekilde tasarlanmıştır. Soğuk hava odalarının duvarları, tavanı ve tabanı 100mm kalınlığında sökülebilir tip poliüretan tectritli paneller kullanılmıştır. Soğuk hava ünitesi, hava soğutmalı kondenserli paket tip cihaz ile çalışmaktadır. Odalardan birisi  $+0^{\circ}\text{C} / +5^{\circ}\text{C}$  arasında diğeri ise  $-18^{\circ}\text{C} / -22^{\circ}\text{C}$  derece ısı aralığına sahiptir. Her soğuk hava odası, elektronik kontrol paneli ile programlanabilmektedir. Soğutma sistemi, üzerindeki dijital termostat vasıtasıyla ayarlanan sıcaklık derecesine kadar çalışıp otomatik olarak durur.

Defrost sistemi, soğutucu üzerinde fazla buzlanma oluştuğu zaman otomatik olarak devreye girer. Soğutucunun istenilen sıcaklık ayarı dijital termostat üzerinden yapılabilir. Konteyner içerisindeki soğuk odalarda metal raflar, derin dondurucuda et askı arabası bulunmaktadır. Konteynerde elektrik olmadığı zamanlarda sistemin çalışabilmesini sağlayacak kapasitede dizel jeneratör

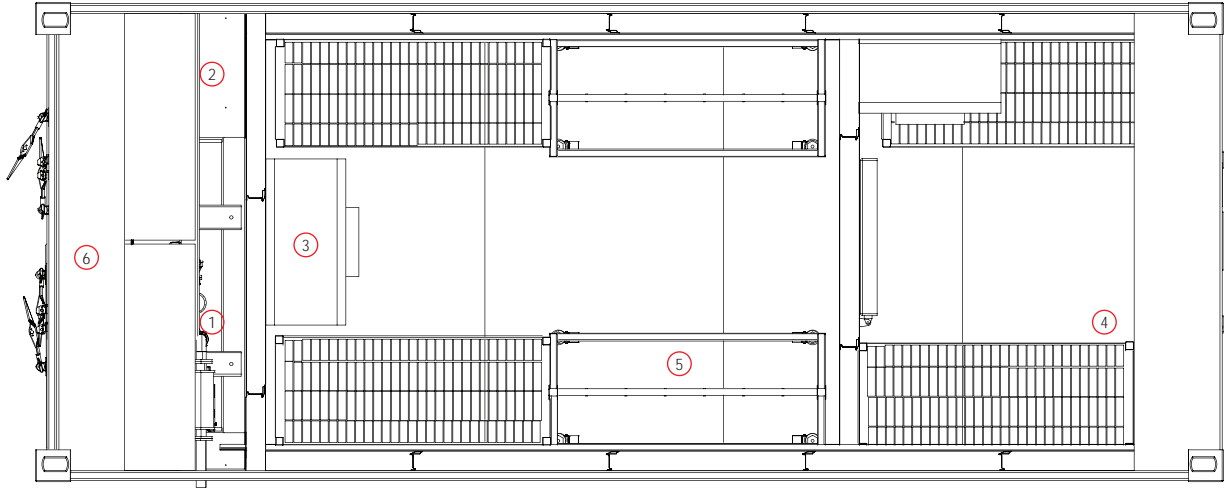
# SEYYAR SAHRA SOĞUK HAVA ÜNİTESİ FIELD COLD ROOM UNIT



	 TR	 EN	 FR
1	Dizel Jeneratör	<i>Diezel Generator</i>	<i>Diezel Generator</i>
2	Soğuk Hava Dış Ünitesi (Kondenser)	<i>Condenser</i>	<i>Condenser</i>
3	Soğutucu (Evaporatör)	<i>Evaporator</i>	<i>Evaporator</i>
4	Metal Raflar	<i>Metal Racks</i>	<i>Metal Racks</i>
5	Et Askı Arabası	<i>Meat Hooking</i>	<i>Meat Hooking</i>
6	Mekanik Ekipman Odası	<i>Technical Room</i>	<i>Technical Room</i>

## SEYYAR ÇAMAŞIR DEPOLAMA ÜNİTESİ LAUNDRY STORAGE UNIT



TR

Taban döşemesi üzeri, sızdırmaz olacak şekilde en az 2/3 mm kalınlığında çetali alüminyum yer kaplaması ile kaplanmış. Taban döşeme altına membranla su yalıtımı sağlanmıştır. İki bölümden oluşur, biri temiz çamaşır diğeri ise kirli çamaşır muhafazası bölümüdür.

- ▷ Konteynerin kısa kenarlarında tek kanatlı dış kapı.
- ▷ 4 adet 4 sıra raflı metal raf sistemi.
- ▷ 1 adet buharlı pres ütü.
- ▷ 4 adet plastik malzemeden imal edilmiş sepet.

EN

The floor is covered with an aluminum floor covering with a minimum thickness of 2/3 mm that is leakproof. Waterproofing with membrane is provided under the floor covering. It consists of two sections, one for clean laundry and one for dirty laundry storage. 4 plastic baskets in a

container. There is a single wing outer door on the short sides of the container. 4 shelves metal rack system with 4 rows in the container

FR

The floor is covered with an aluminum floor covering with a minimum thickness of 2/3 mm that is leakproof. Waterproofing with membrane is provided under the floor covering. It consists of two sections, one for clean laundry and one for dirty laundry storage. 4 plastic baskets in a container.

There is a single wing outer door on the short sides of the container. 4 shelves metal rack system with 4 rows in the container

# SEYYAR ÇAMAŞIR DEPOLAMA ÜNİTESİ PORTABLE LAUNDRY STORAGE UNIT

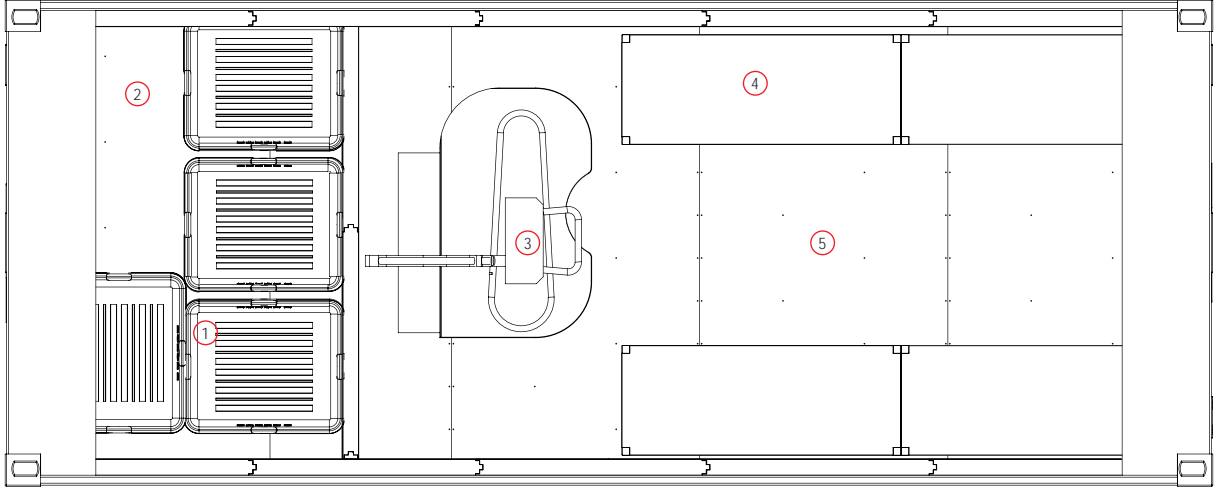

	 TR	 EN	 FR
1	Plastik Sepetler	Plastic Baskets	Plastic Baskets
2	Kirli Çamaşır Depolama Bölümü	Dirty Laundry Area	Dirty Laundry Area
3	Buharlı Pres Ütü	Pres Ironing	Pres Ironing
4	Metal Raf Sistemi	Metal Rackets	Metal Rackets
5	Temiz Çamaşır Depolama Bölümü	Clean Laundry Area	Clean Laundry Area

## SEYYAR SAHRA UN DEPOLAMA ÜNİTESİ FIELD FLOUR STORAGE UNIT



-  **TR** Taban döşemesi üzeri, sızdırmaz olacak şekilde en az 2/3 mm. kalınlığında çetalı alüminyum yer kaplaması ile kaplanmıştır. Taban döşeme altına membranla su yalıtımı sağlanmıştır. Konteynerin kısa kenarının birinde tek kanatlı dış kapı vardır. Konteyner içerisinde;
- ▷ 800x1200 mm ölçülerinde 8 adet plastik palet.

- ▷ 12000 BTU kapasitesinde inverter klima.
- ▷ Konteynerde elektrik olmadığı zamanlarda sistemin çalışabilmesini sağlayacak kapasitede dizel jeneratör

-  **EN** At least 2/3 mm the floor is covered with thick aluminum floor covering. Under the floor covering, membrane waterproofing is provided. Single wing outer door on one of the short sides of the container.
- In the container;
- ▷ 8 plastic pallets measuring 800x1200 mm in the container.



- ▷ Inverter air conditioner with a capacity of 12000 BTU in the container.
- ▷ Diesel generator with the capacity to operate the system when there is no electricity in the container

-  **FR** At least 2/3 mm the floor is covered with thick aluminum floor covering. Under the floor covering, membrane waterproofing is provided. Single wing outer door on one of the short sides of the container.
- In the container;
- ▷ 8 plastic pallets measuring 800x1200 mm in the container.

- ▷ Inverter air conditioner with a capacity of 12000 BTU in the container.
- ▷ Diesel generator with the capacity to operate the system when there is no electricity in the container

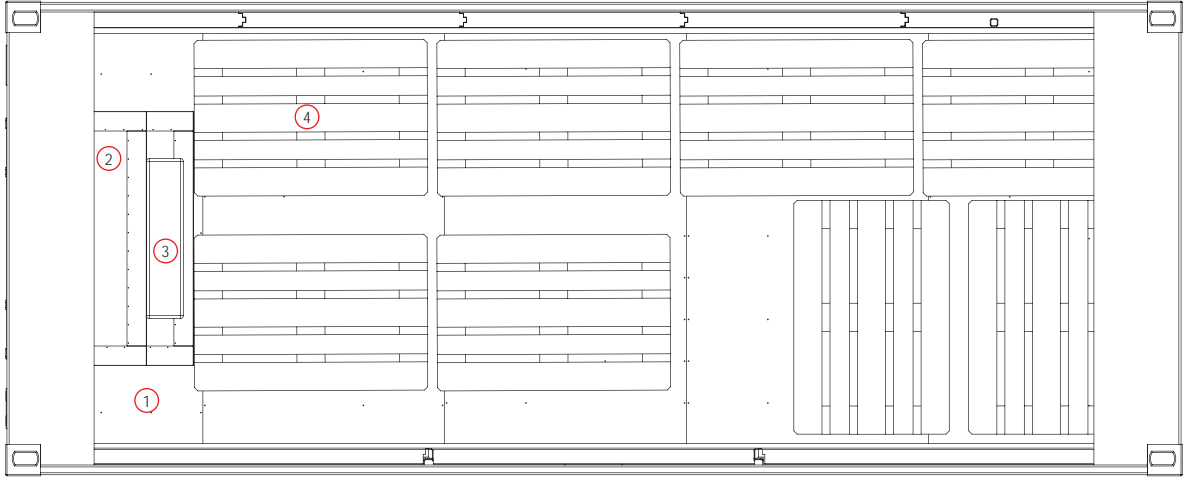
# SEYYAR SAHRA UN DEPOLAMA ÜNİTESİ MOBILE FIELD FLOUR STORAGE UNIT



	 TR	 EN	 FR
1	Dizel Jeneratör	<i>Diezel Generator</i>	<i>Diezel Generator</i>
2	Havalandırma Menfezi	<i>Air Ventilator</i>	<i>Air Ventilator</i>
3	İnvertör Klima	<i>A/C</i>	<i>A/C</i>
4	Plastik Pale	<i>Plastic Pallets</i>	<i>Plastic Pallets</i>

# SEYYAR SAHRA ERZAK DEPOLAMA ÜNİTESİ MOBILE FIELD FOOD STORAGE UNIT



TR Taban döşemesi üzeri, sızdırmaz olacak şekilde 2/3 mm kalınlığında çetali alüminyum yer kaplaması ile kaplanmış, taban döşeme altında membranla su yalıtımı. Konteynerin kısa kenarının birinde çift kanatlı dış kapı yapılmıştır. Konteyner içerisinde 800x1200 mm ölçülerinde 4 adet

plastik palet. Konteyner içerisinde 4 adet, 4 sıra raflı krom çelik metal raf sistemi. 12000 BTU kapasitesinde inverter klima ve elektrik olmadığı zamanlarda sistemin çalışabilmesini sağlayacak kapasitede dizel jeneratör bulunmaktadır.

EN The floor is covered with a 2/3 mm thick aluminum floor covering. Membrane waterproofing under the floor covering. On one of the short sides of the container, there is a double wing outer door in the container;  
▷4 plastic pallets.

▷Chrome steel metal shelving system with 4 rows Inverter air conditioner, with 12000 BTU capacity.  
▷Diesel generator with the capacity to operate the system when there is no electricity in the container



FR The floor is covered with a 2/3 mm thick aluminum floor covering. Membrane waterproofing under the floor covering. On one of the short sides of the container, there is a double wing outer door in the container;  
▷4 plastic pallets.

▷Chrome steel metal shelving system with 4 rows Inverter air conditioner, with 12000 BTU capacity.  
▷Diesel generator with the capacity to operate the system when there is no electricity in the container

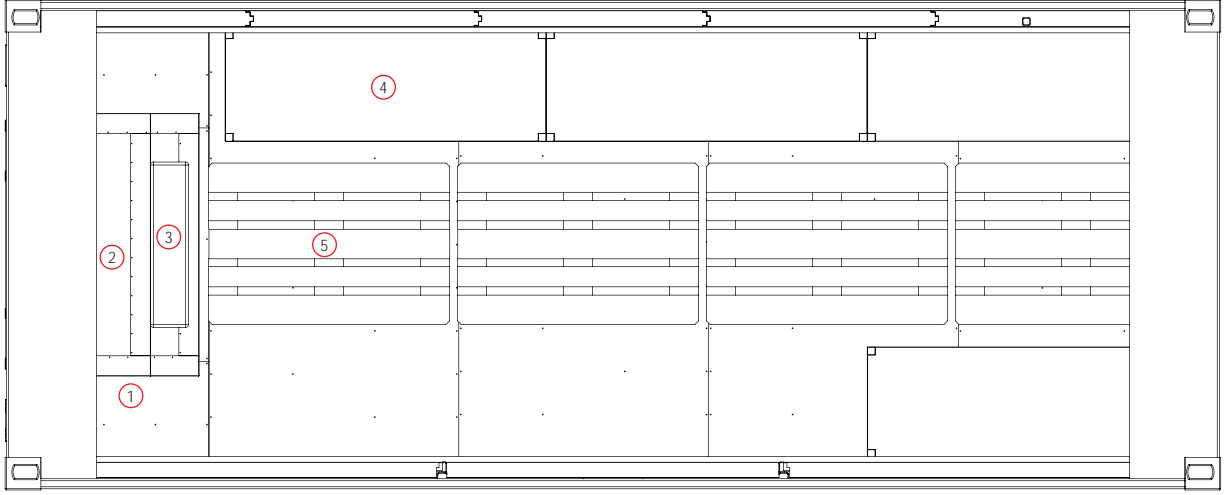

# SEYYAR SAHRA ERZAK DEPOLAMA ÜNİTESİ MOBILE FIELD FOOD STORAGE UNIT



	 TR	 EN	 FR
1	Dizel Jeneratör	<i>Diezel Generator</i>	<i>Diezel Generator</i>
2	Havalandırma Menfezi	<i>Air Ventilator</i>	<i>Air Ventilator</i>
3	İnvertör Klima	<i>A/C</i>	<i>A/C</i>
4	Metel Raf Sistemi	<i>Metal Rockes</i>	<i>Metal Rockes</i>
5	Plastik Palet (4 Adet)	<i>Plastic Pallet (4 pcs)</i>	<i>Plastic Pallet (4 pcs)</i>

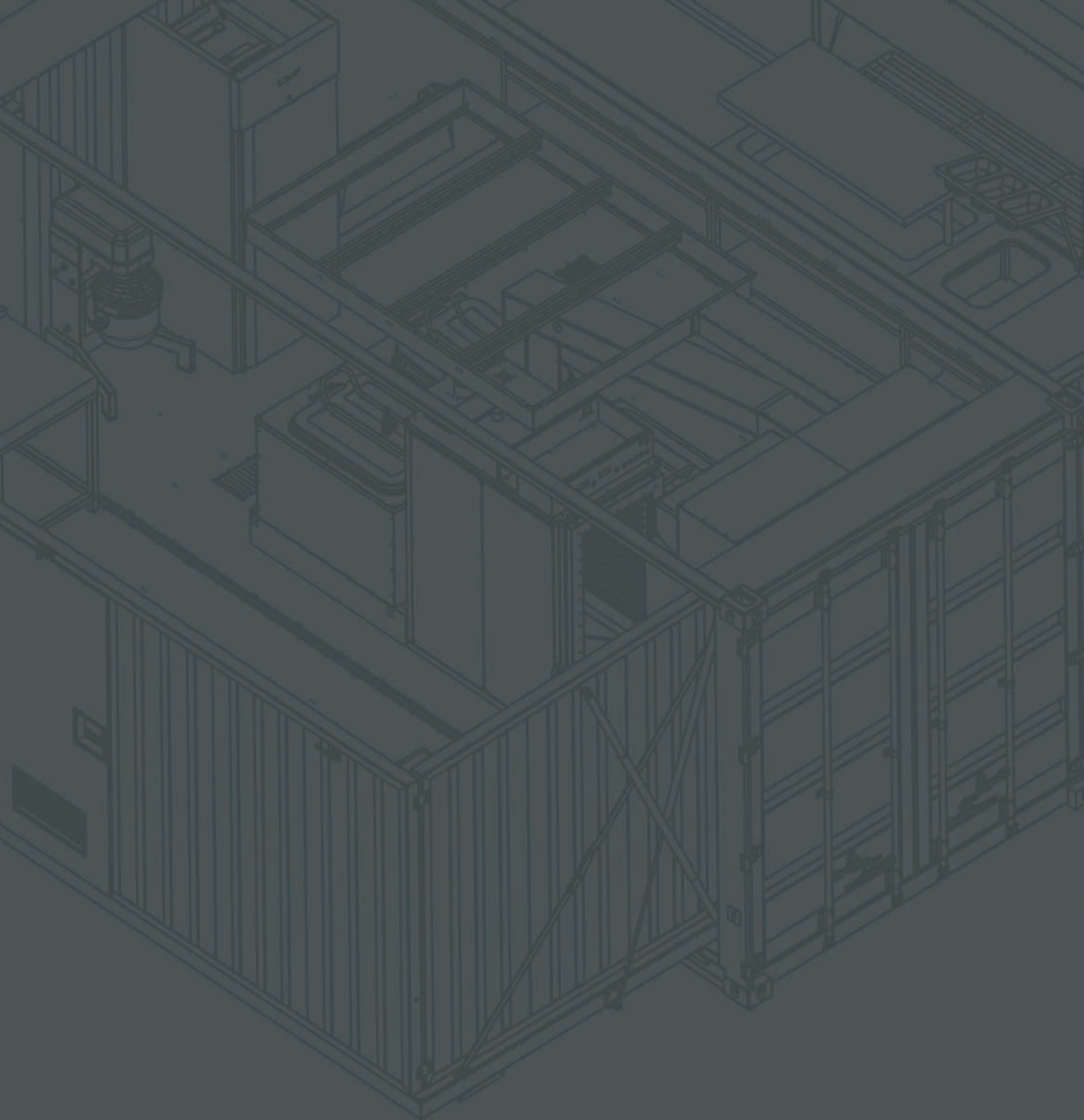

**öztiryakiler**

SAVUNMA EKİPMANLARI SAN. TİC. A.Ş.



**Merkez / Company:** Gümüflsuyu Cad. Fazılpaşa Çıkması No: 13 Topkapı / İstanbul - Türkiye  
**Ofis / Office:** Cumhuriyet Mah. Eski Hadımköy Yolu Cad. No:8 34500 Büyükçekmece / İstanbul - Türkiye  
**Fabrika / Factory:** Vakıflar OSB Mah. Sanayi Caddesi NO:33/1 Ergene/TEK·RDA/